

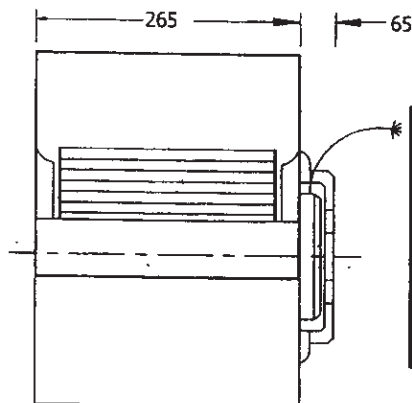

DIRECT DRIVE DOUBLE INLET DOUBLE WIDTH CENTRIFUGAL FAN
DD 10-8 600W 4 POLE 3SPD

ISSUE: 4.3
PART NUMBER 610860
DATE: 20/03/01

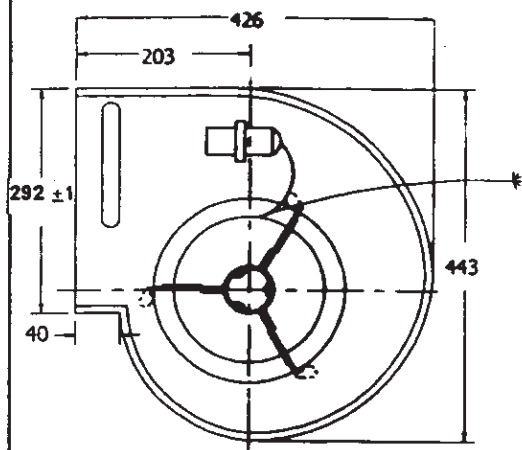

WIRING DIAGRAM	
WHITE	LOW
GREY	MEDIUM
BROWN	HIGH
BLUE	NEUTRAL
GREEN / YELLOW	EARTH
ORANGE	CAPACITOR

MOTOR CODE:	K00051	NOISE (LPS) dB(A)	FREE FIELD NOISE MEASURED AT 1m
MOTOR RPM	1300	PROTECTION	IP 20
AMP. MAX.	5.3	VOLTAGE	240
TEMPERATURE	MIN -20; Max +40	THERMAL OVERLOAD PROTECTION	YES
CAPACITOR	15 µF	CAPACITOR LEAD	300±30mm
INSULATION CLASS	B	MAIN LEAD	1200±30mm

